



MIT
Science, Technology, and
Global Security Working Group

Possible Implications of Faulty US Technical Intelligence in the Damascus Nerve Agent Attack of August 21, 2013

Richard Lloyd
Former UN Weapons Inspector
Tesla Laboratories Inc. | Arlington, VA
Voice: 509-979-3995; e-mail: rlloyd@tesla.net

Theodore A. Postol
Professor of Science, Technology, and National Security Policy
Massachusetts Institute of Technology
Voice: 617 543-7646; e-mail: postol@mit.edu

Washington, DC
January 14, 2014

1

What is the Main Policy Issue?

- The Syrian Improvised Chemical Munitions that Were Used in the August 21, Nerve Agent Attack in Damascus Have a Range of About 2 Kilometers
- The UN Independent Assessment of the Range of the Chemical Munition Is in Exact Agreement with Our Findings
- This Indicates That These Munitions Could Not Possibly Have Been Fired at East Ghouta from the "Heart", or from the Eastern Edge, of the Syrian Government Controlled Area Shown in the Intelligence Map Published by the White House on August 30, 2013.
- This mistaken Intelligence Could Have Led to an Unjustified US Military Action Based on False Intelligence.
- A Proper Vetting of the Fact That the Munition Was of Such Short Range Would Have Led to a Completely Different Assessment of the Situation from the Gathered Data
- Whatever the Reasons for the Egregious Errors in the Intelligence, the Source of These Errors Needs to Be Explained.
- If the Source of These Errors Is Not Identified, the Procedures that Led to this Intelligence Failure Will Go Uncorrected, and the Chances of a Future Policy Disaster Will Grow With Certainty.

2

Claims from US Technical Intelligence that are Inconsistent With Physics-Based Objective Facts

Statement on Syria

Remarks
John Kerry
Secretary of State
Treaty Room
Washington, DC
August 30, 2013

Our intelligence community has carefully reviewed and re-reviewed information regarding this attack, and I will tell you it has done so more than mindful of the Iraq experience. We will not repeat that moment. Accordingly, we have taken unprecedented steps to declassify and make facts available to people who can judge for themselves.

...

We know where the rockets were launched from and at what time. We know where they landed and when. We know rockets came only from regime-controlled areas and went only to opposition-controlled or contested neighborhoods.

And we know, as does the world, that just 90 minutes later all hell broke loose in the social media.

...

for four days they shelled the neighborhood in order to destroy evidence, bombarding block after block at a rate four times higher than they had over the previous 10 days.

...

In all of these things that I have listed, in all of these things that we know, all of them, the American intelligence community has high confidence, high confidence. This is common sense. This is evidence. These are facts.

...

So now that we know what we know, the question we must all be asking is: What will we do?

...

By the definition of their own mandate, the UN can't tell us anything that we haven't shared with you this afternoon or that we don't already know. And because of the guaranteed Russian obstructionism of any action through the UN Security Council, the UN cannot galvanize the world to act as it should.

...

President Obama will ensure that the United States of America makes our own decisions on our own timelines based on our values and our interests.

...

So that is what we know. That's what the leaders of Congress now know. And that's what the American people need to know. And that is at the core of the decisions that must now be made for the security of our country

3

Claims from US Technical Intelligence that are Inconsistent With Physics-Based Objective Facts

Opening Remarks Before the United States Senate Committee on Foreign Relations

Testimony
John Kerry
Secretary of State
Washington, DC
September 3, 2013

I remember Iraq. Secretary Hagel remembers Iraq. General Dempsey especially remembers Iraq.

...

that is why our intelligence community has scrubbed and re-scrubbed the evidence. We have declassified unprecedented amounts of information. And we ask the American people and the rest of the world to judge that information.

...

We have physical evidence of where the rockets came from and when.

...

We have a map, physical evidence, showing every geographical point of impact – and that is concrete.

...

We are certain that none of the opposition has the weapons or capacity to effect a strike of this scale – particularly from the heart of regime territory.

...

So my colleagues, we know what happened. For all the lawyers, for all the former prosecutors, for all those who have sat on a jury – I can tell you that we know these things beyond the reasonable doubt that is the standard by which we send people to jail for the rest of their lives.

...

As confidently as we know what happened in Damascus, my friends, on August 21st, we know that Assad would read our stepping away or our silence as an invitation to use those weapons with impunity.

4

Claims from US Technical Intelligence that are Inconsistent With Physics-Based Objective Facts

<http://www.whitehouse.gov/the-press-office/2013/08/30/government-assessment-syrian-government-s-use-chemical-weapons-august-21>

Statement:

Multiple streams of intelligence indicate that the regime executed a rocket and artillery attack against the Damascus suburbs in the early hours of August 21. **Satellite detections corroborate that attacks from a regime-controlled area** struck neighborhoods where the chemical attacks reportedly occurred – including Kafr Batna, Jawbar, 'Ayn Tarma, Darayya, and Mu'addamiyah. **This includes the detection of rocket launches from regime controlled territory early in the morning, approximately 90 minutes before the first report of a chemical attack** appeared in social media. **The lack of flight activity or missile launches also leads us to conclude that the regime used rockets in the attack.**

Issue:

Satellite technical intelligence is one of the most reliable technologies available to the US intelligence community. Satellite measurements provide highly reliable rocket launch point locations to fractions of a kilometer.

5

White House Map Published on August 30, 2013 Showing Government Controlled Area

www.whitehouse.gov/sites/default/files/docs/2013-08-30_map_accompanying_usg_assessment_on_syria.pdf

Syria: Damascus Areas of Influence and Areas Reportedly Affected by 21 August Chemical Attack

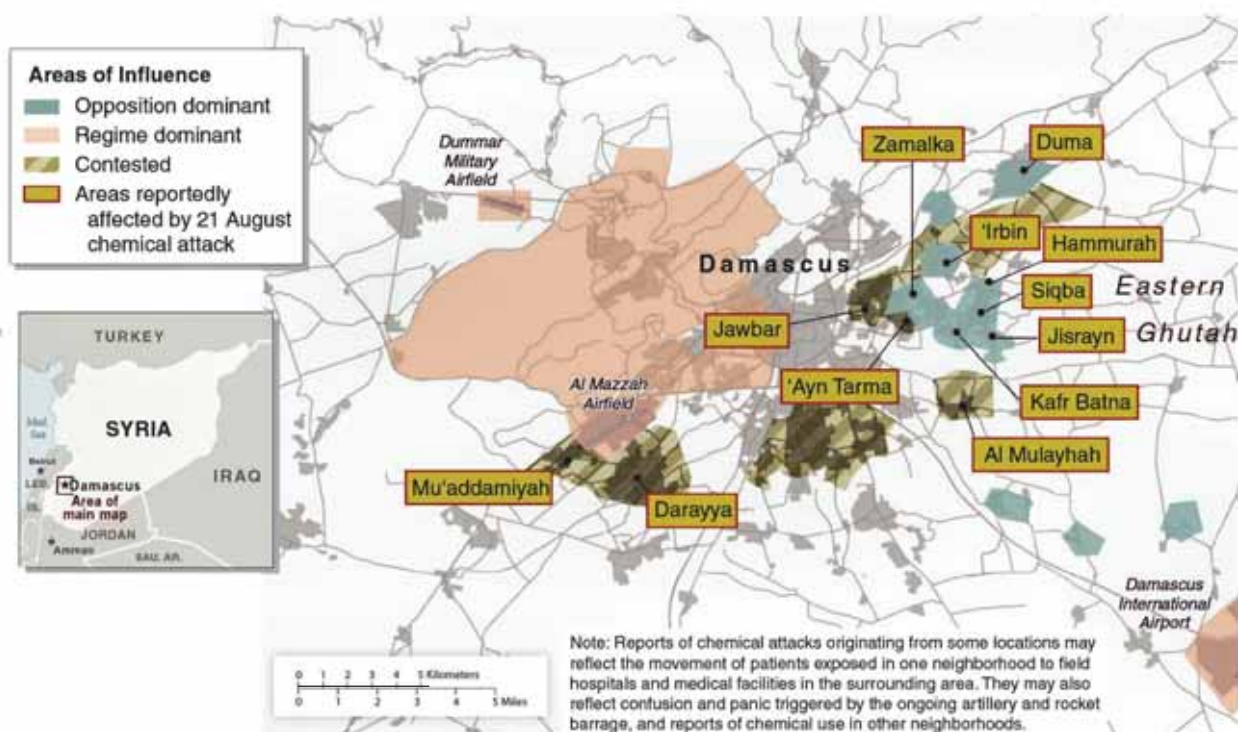

6

Syria: Damascus Areas of Influence and Areas Reportedly Affected by 21 August Chemical Attack

Ranges from the "Heart" and Extreme Eastern Edge of Syrian Government Controlled Areas to Zamalka

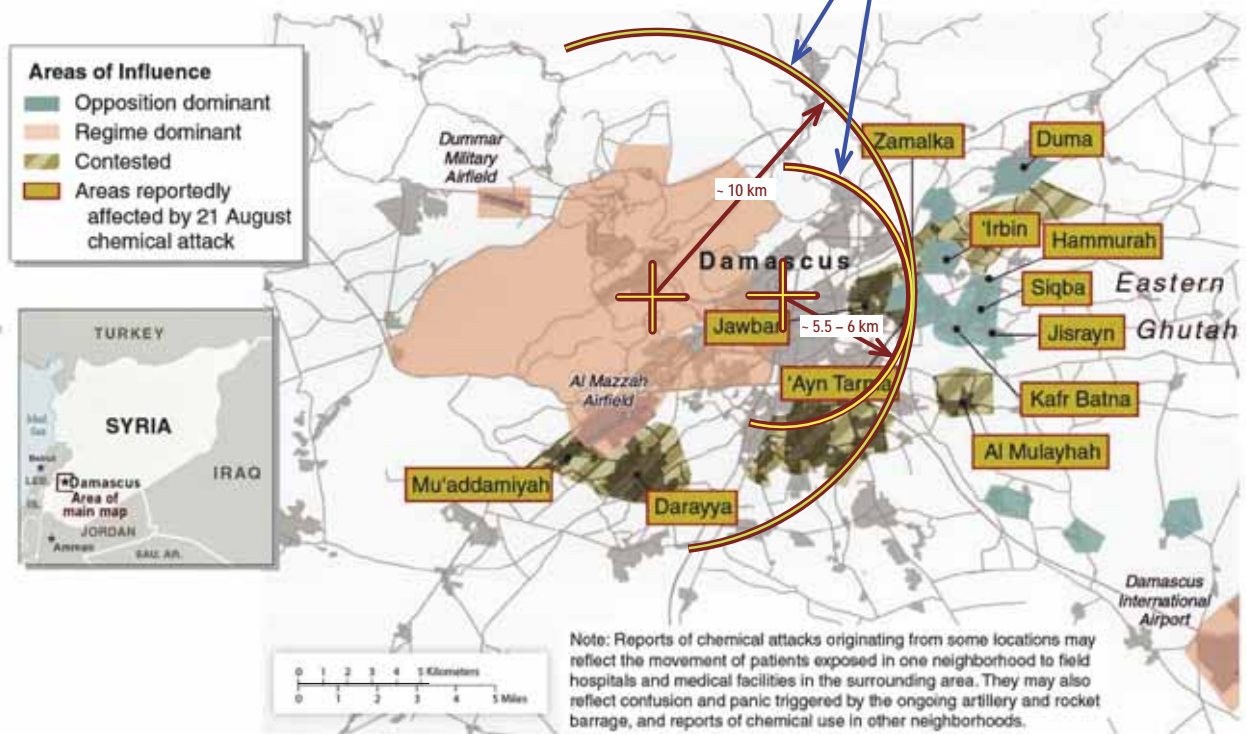

Syria: Damascus Areas of Influence and Areas Reportedly Affected by 21 August Chemical Attack

Ring of Maximum Ranges from Where Chemical Munitions Could Have Been Launched

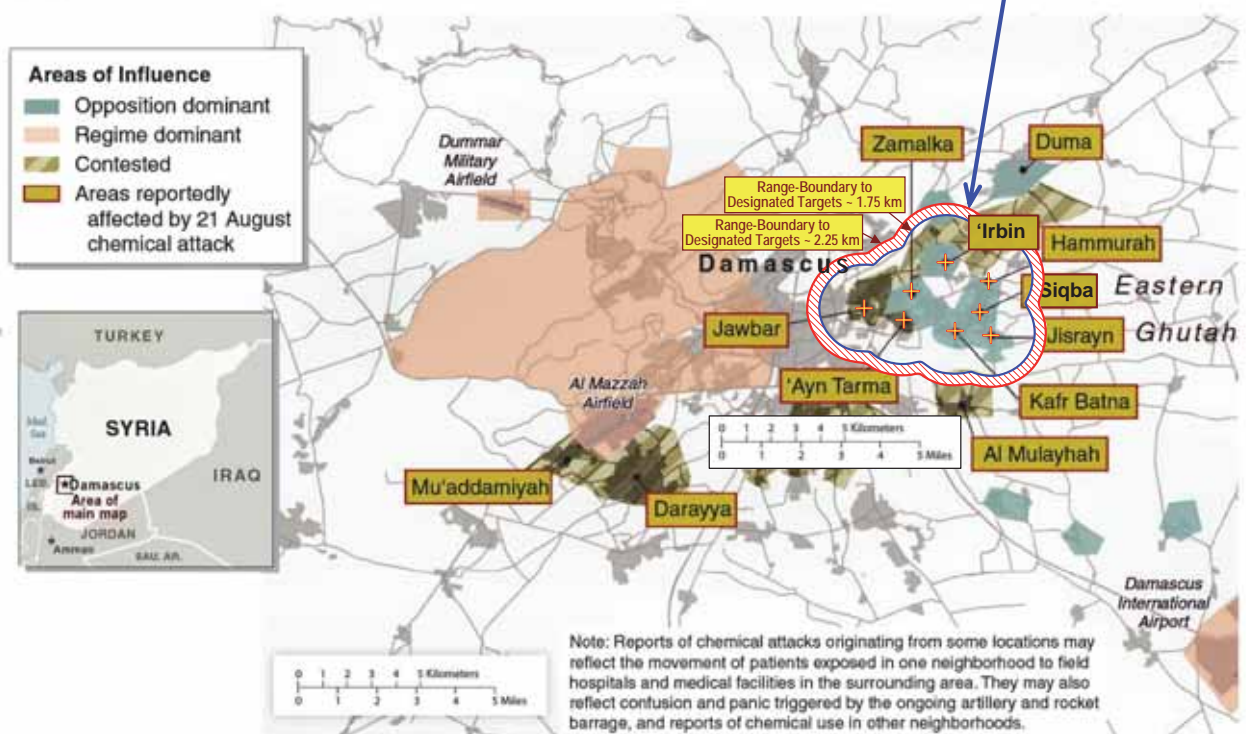

White House Map Published on August 30, 2013 Showing Government Controlled Area and Ring of Maximum Ranges from Where Chemical Munitions Could Have Been Launched

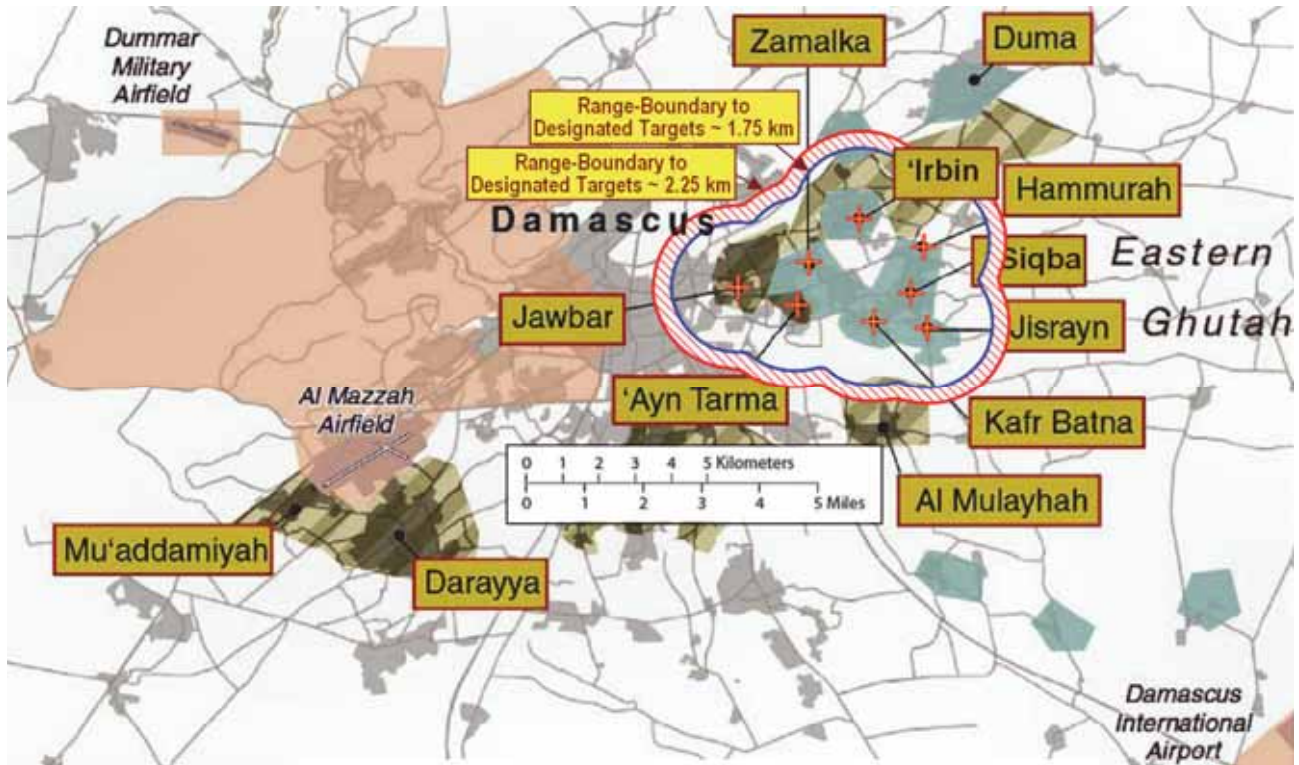

9

White House Map Published on August 30, 2013 Showing Government Controlled Area and Ring of Maximum Ranges from Where Chemical Munitions Could Have Been Launched

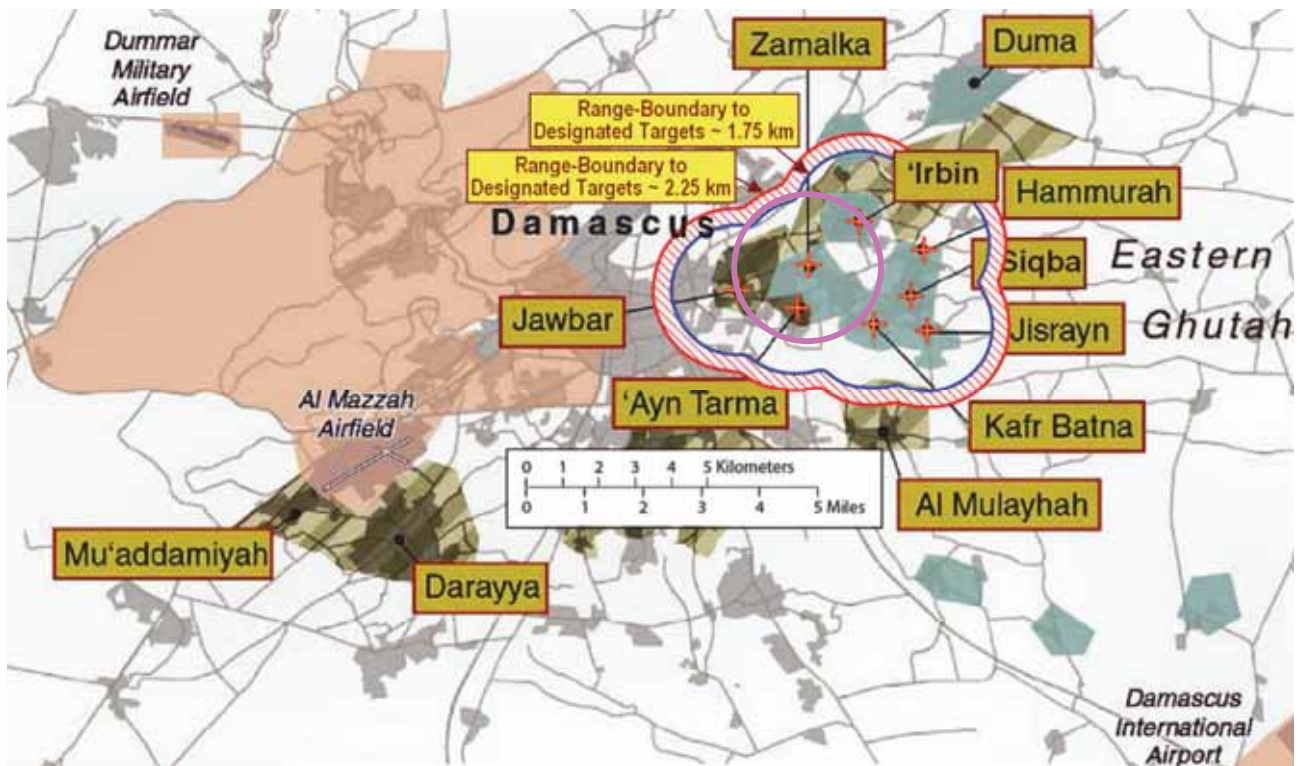

10

- The Range Does Not Change Drastically with Significant Changes in the Body Weight or Due to Uncertainties in the Aerodynamic Drag Coefficient.
- Due to Volume and Fuel Density Constraints, Our Assumption of Rocket Propellant Carried by the Munition is at the Top End of What is Possible.

This Means that Our Estimated Maximum Range of 2 km for the Improvised Munition Is Close to its Upper Possible Range!

In Turn, It Means That the US Government's *Interpretation of the Technical Intelligence* It Gathered Prior to and After the August 21 Attack **CANNOT POSSIBLY BE CORRECT**

11

Remainder of Talk

- Discusses How the Indigenous Chemical Munition Could Be Manufactured By Anyone Who Has Access to a Machine Shop With Modest Capabilities That Is, the Claim Is Incorrect that Only the Syrian Government Could Manufacture the Munition.
- Shows Why the Range Estimate of Roughly Two Kilometers Hardly Changes If the Munition Carries a Lighter Payload.

Appendices

1. Source Data on GRAD Aerodynamic Drag Coefficient
2. Source Data on the GRAD Rocket Motor Characteristics
3. Description of Capabilities of Space-Based Sensors Used to Detect the Rocket Launches in the Damascus Attack

12

What Does the Improvised Chemical Munition Look Like and How Was It Constructed

13

GRAD Artillery Rocket NYT September 5, 2013

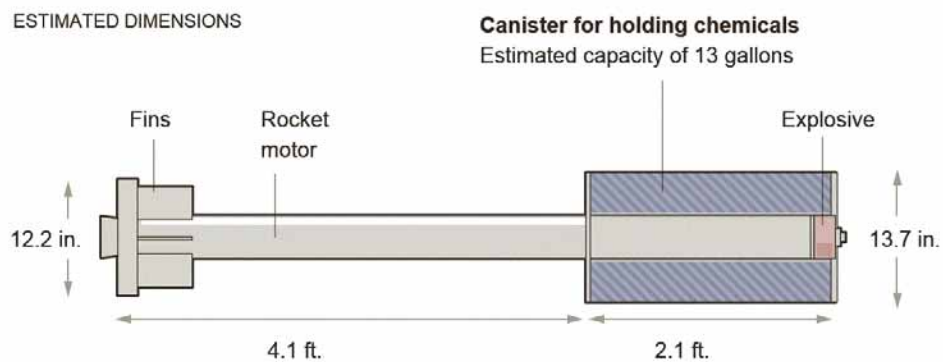

Rocket parts were found distorted by the impact, but not fragmented, indicating that they carried a small quantity of explosives. This helps keep the integrity of the chemical agent.

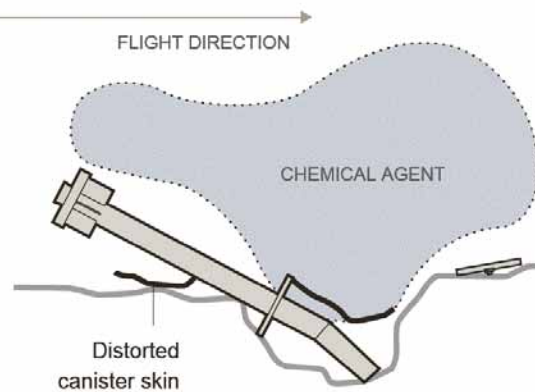

September 5, 2013

14

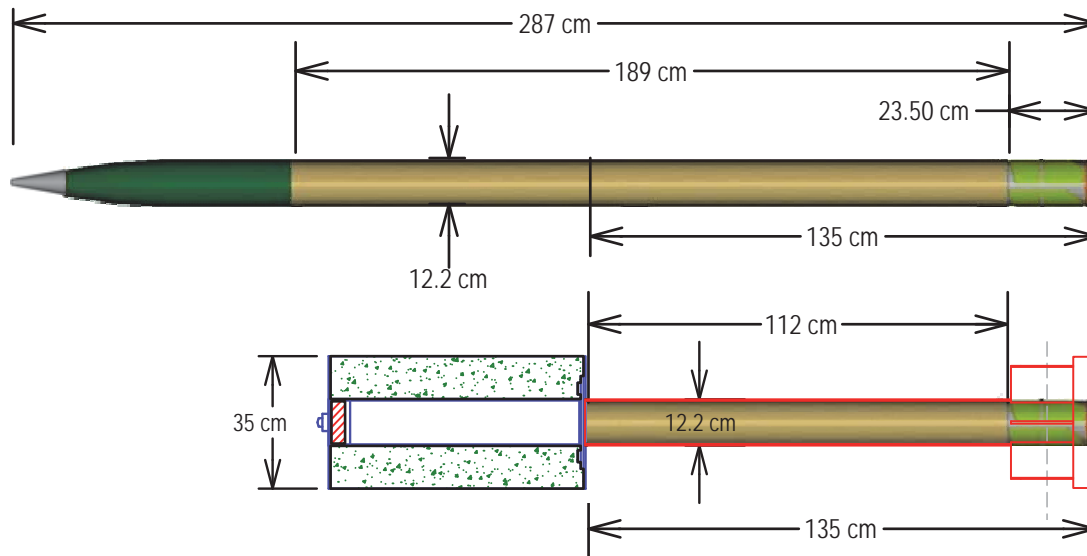

Full Rocket Motor Contains 20.45 kg of Propellant
 Half Motor Contains 10.22 kg of Propellant
 60% Motor Contains 12.27 kg of Propellant
 (112 cm of 189 cm GRAD Rocket Motor)

Technical Characteristics of the GRAD Artillery Rocket and Its Rocket Motor

TACTICAL AND TECHNICAL CHARACTERISTICS OF THE 122mm ROCKETS "GRAD" AND THEIR MODIFICATIONS

Basic characteristics of the existing "GRAD", "G-M" and "G-2000" at nominal

	GRAD	G-M	G-2000	Units
Caliber	122	122	122	mm
Length	2875	2875	2875	mm
Temperature range	-30 ± 50	-30 ± 50	-30 ± 50	°C
Total mass	66	68.7	69.0	kg
Warhead mass with fuse	19.1	19.1	19.1	kg
Propellant mass	20.45	25.8	27.3	kg
Burning time	2.0	2.5	2.7	s
Total motor impulse	39700	52700	62800	Ns
Specific motor impulse	1941	2042	2300	Ns/kg
Max. velocity at X _e .	690.6	915	1100	m/s
Top of the trajectory at X _e .	7100	11100	17800	m
Time of flight at X _e .	76	96	126	s
Elevation	50.0	50.0	56.9	°
Range (X _e)	20.3	27.5	40.2	km
Caliber	122	122	122	mm

Characteristics of GRAD Rocket Motor Needed to Determine Missile Trajectory

Trajectory Characteristics that Result from GRAD Rocket Motor Properties

Specific Impulse of GRAD (I_{sp}) = 198 sec
 Rocket Motor Length ~ 188 cm
 12.45 kg Propellant Mass
 → 0.1088 kg/cm of Propellant in Motor

GRAD Artillery Rocket

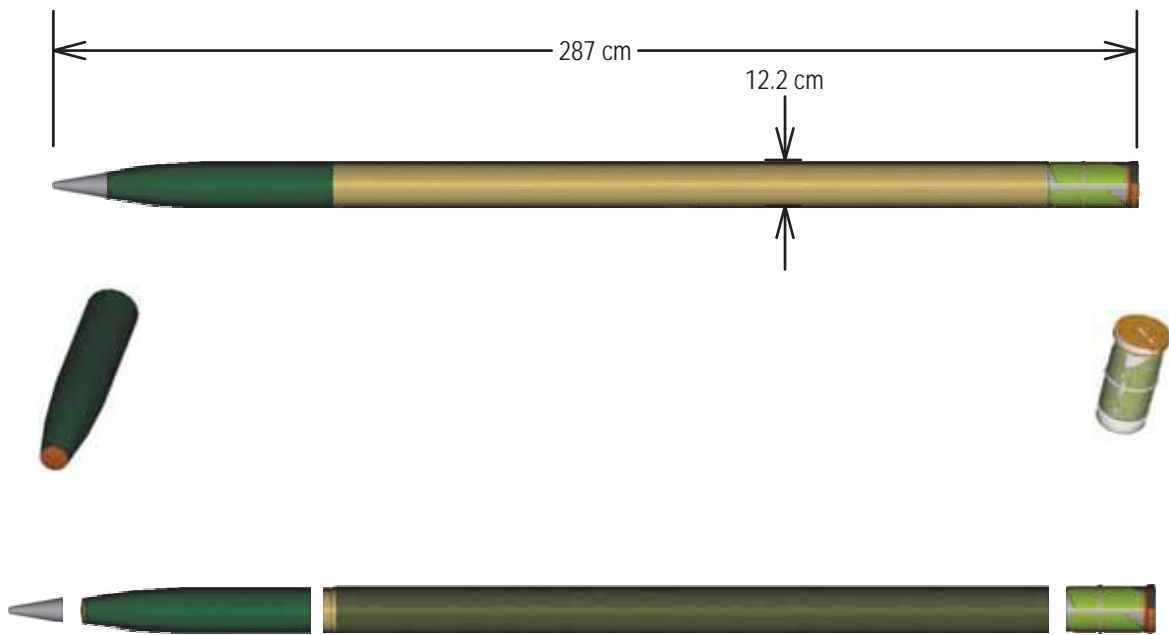

17

GRAD Artillery Rockets are a Ubiquitous Weapon

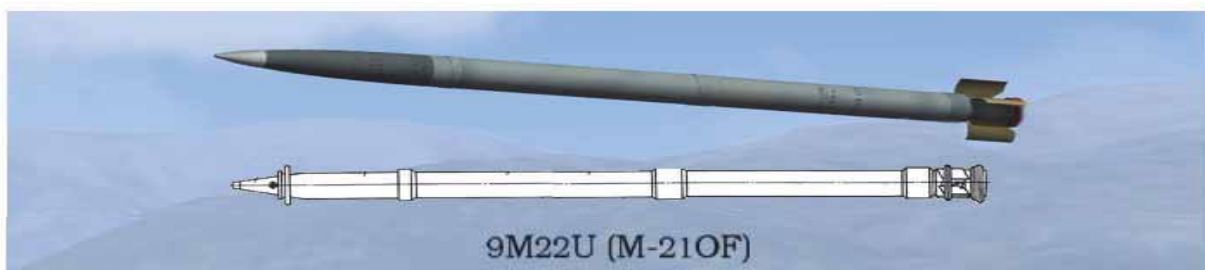

18

Possible Adaptation of GRAD Artillery Rocket Motor for Chemical Munition Used in Damascus

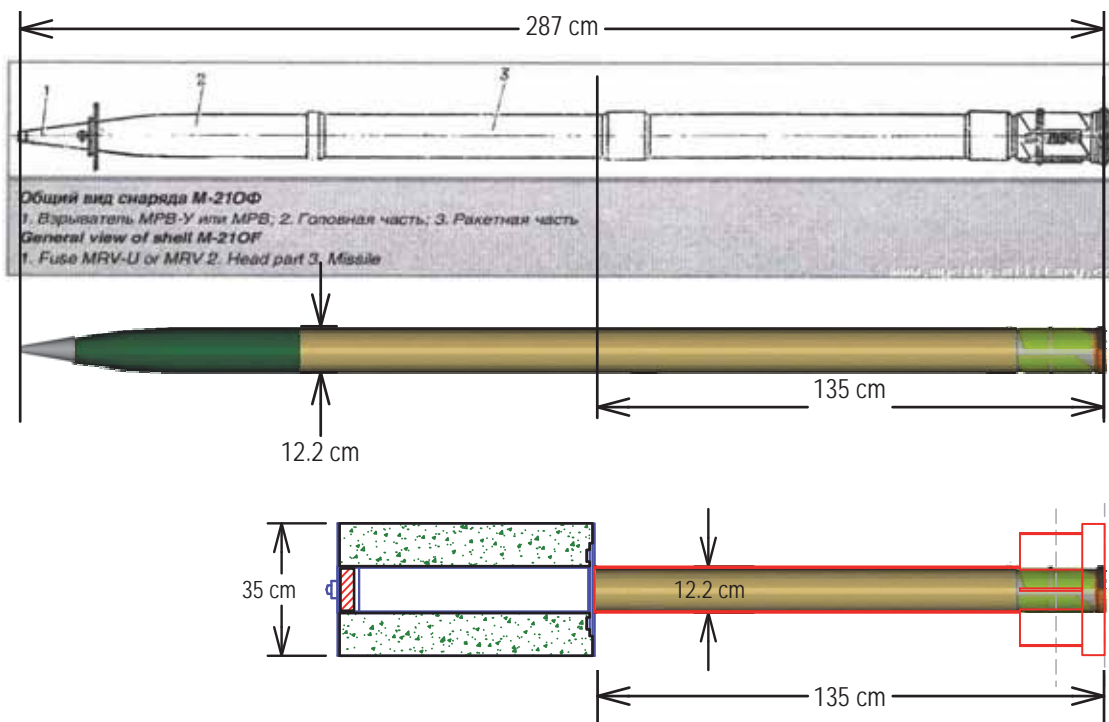

Full Rocket Motor Contains 20.45 kg of Propellant
Half Motor Contains 10.22 kg of Propellant
60% Motor Contains 12.27 kg of Propellant
IF ROCKET MOTOR IS 112 cm LONG
~ 5cm -0.5kg Less Propellant; 10 cm ~ 1 kg Less Propellant

19

Rocket-Motor Back End Housing of Chemical Munition Used in Damascus Attack of August 21, 2013

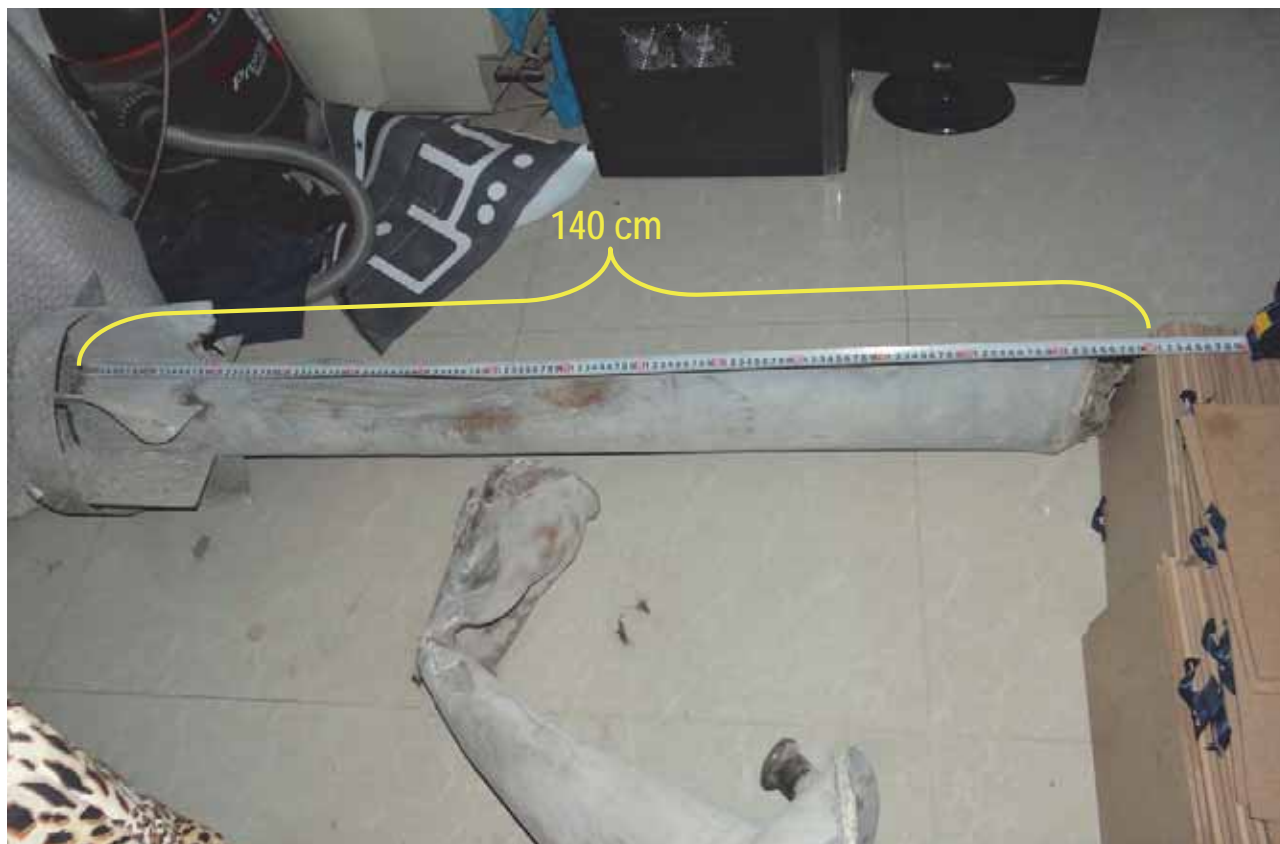

20

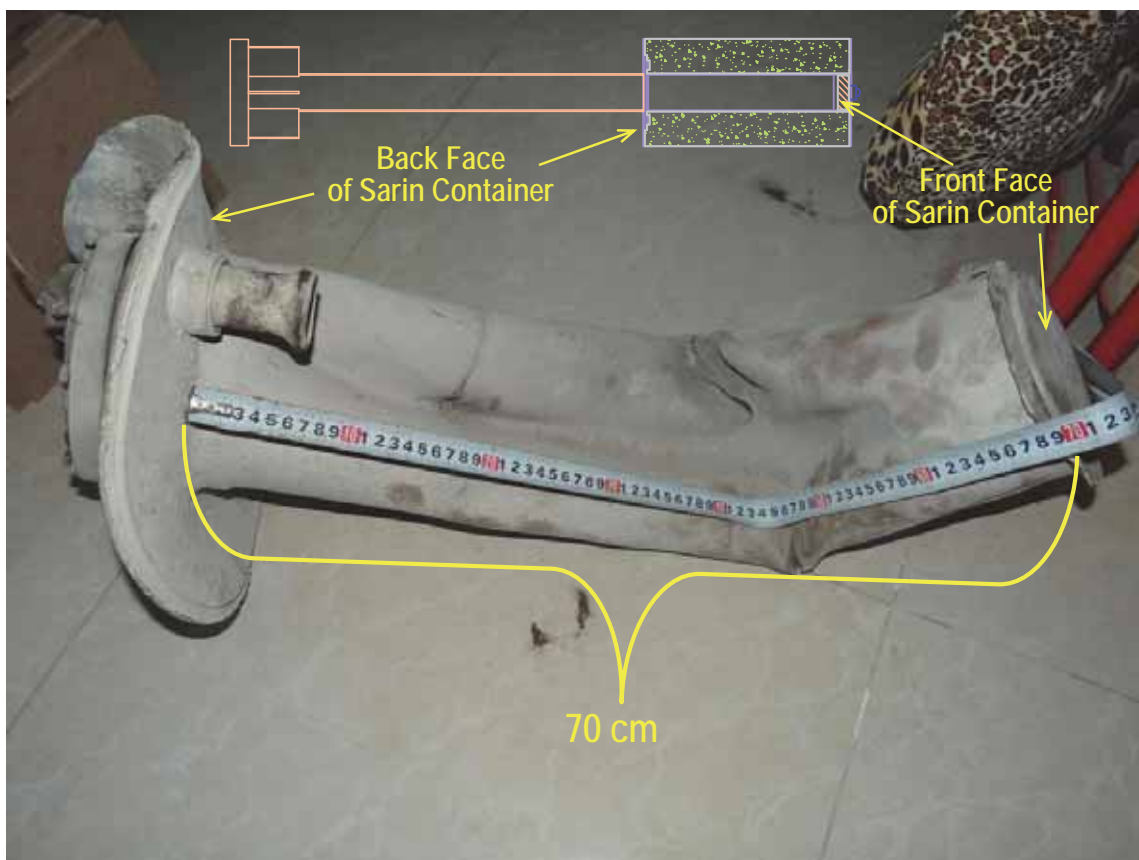

21

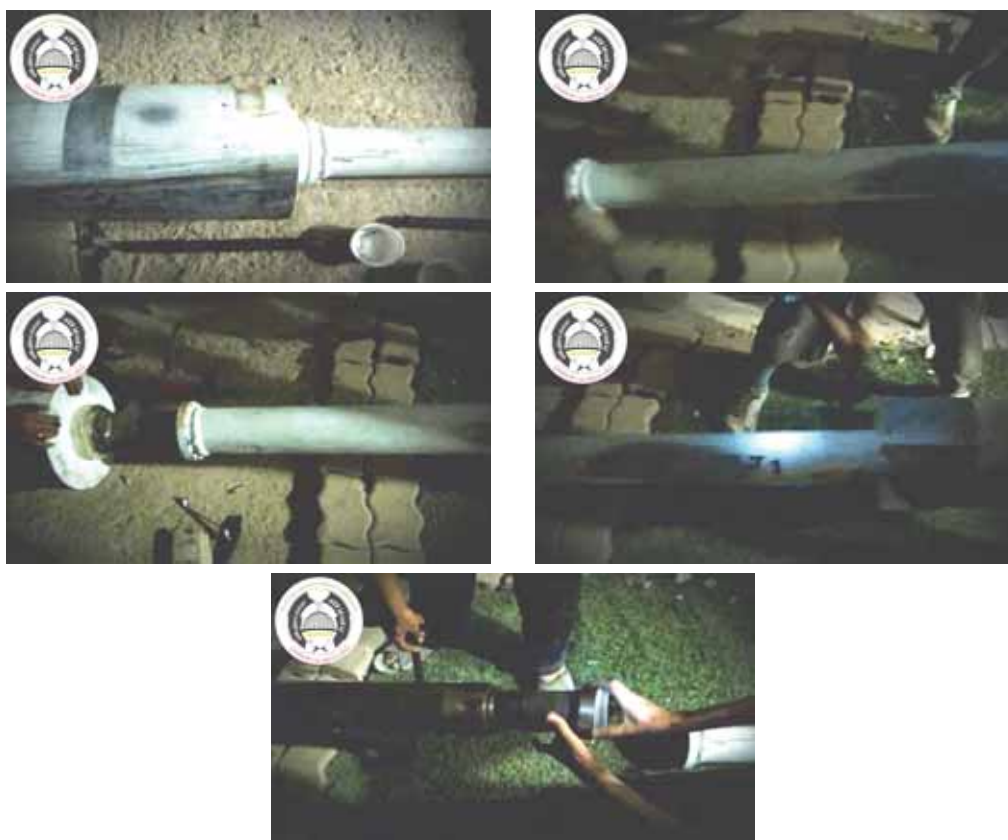

22



23

Diagram of Improvised Chemical Artillery Rocket from UN Report of September 18, 2013

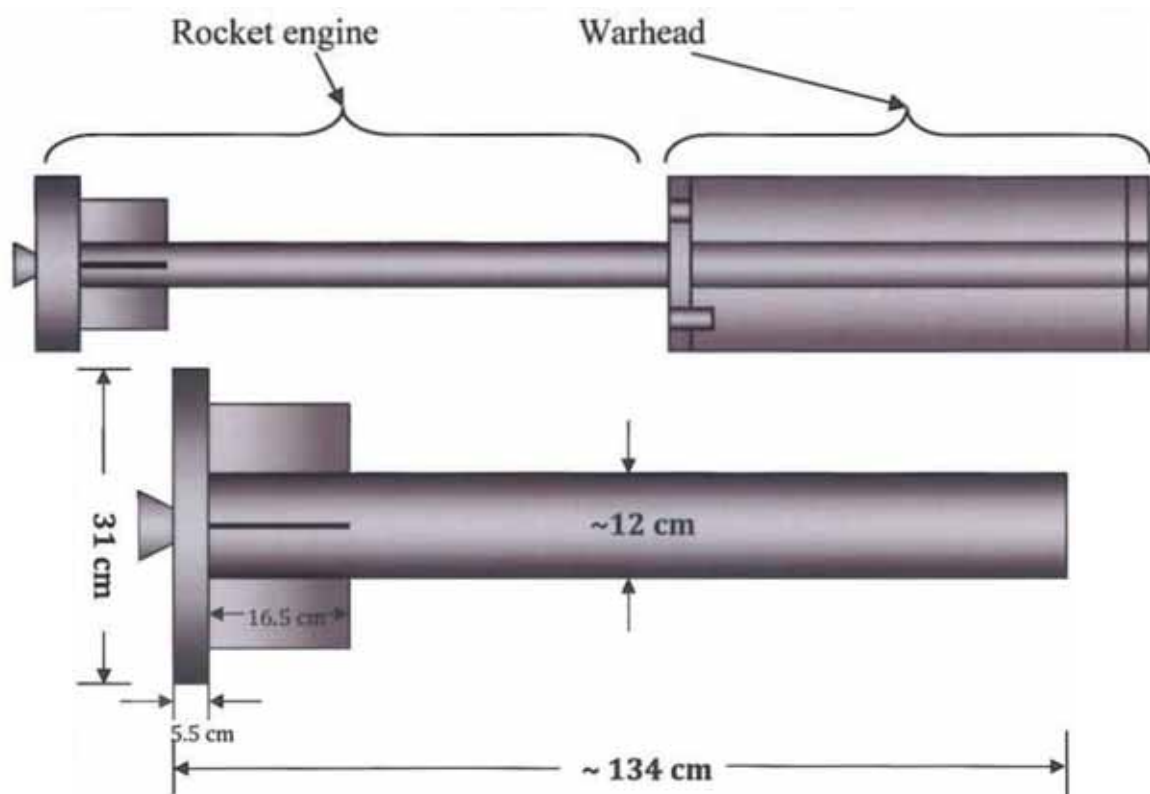

24



25

Rough Estimate of the Possible Weight of the Chemical Munition Without Its Inserted Rocket Motor

Pipe Structure for Rocket Motor and for the Axial Mechanical Support of the Sarin Container

$$\pi \cdot (12.2^2 - 11.8^2) \cdot 130 \cdot 0.0079 = 30.9736$$

$$\pi \cdot (12.2^2 - 11.9^2) \cdot 130 \cdot 0.0079 = 23.3270$$

$$\text{End Plate: } (\pi \cdot 18^2) \cdot .5 \cdot 0.0079 = 4.0206 \text{ kg}$$

Two End Plates: 8 kg

$$\text{Rear End Plate Strengthening Ring: } \pi \cdot (12^2 - 6^2) \cdot 1 \cdot 0.0079 = 2.6804 \text{ kg}$$

$$\text{Six Fins} = 6 \cdot 22 \cdot 9.5 \cdot .4 \cdot 0.0079 = 3.9626 \text{ kg}$$

$$\text{Fin Strengthening Ring} = 2 \cdot \pi \cdot 15.5 \cdot 5 \cdot .4 \cdot 0.0079 = 1.5388 \text{ kg}$$

Sarin = 55 kg

$$\text{Metal Skin of Sarin Container} = 2 \cdot \pi \cdot 17.5 \cdot 70 \cdot .2 \cdot 0.0079 = 12.1611 \text{ kg}$$

$$2 \cdot \pi \cdot 17.5 \cdot 70 \cdot .15 \cdot 0.0079 = 9.1208 \text{ kg}$$

Metal Skin for Rocket Motor Casing = 7 kg?

Other Hardware = 5 kg

$$30.9736 + 8 + 2.6804 + 3.9626 + 1.5388 + 12.1611 + 7 + 5 + 55 = 126.3165 \text{ kg Total Weight Without Rocket Motor}$$

$$23.3270 + 8 + 2.6804 + 3.9626 + 1.5388 + 9.1208 + 7 + 55 = 110.6296 \text{ kg Total Weight Without Rocket Motor}$$

We Estimate a Weight-Range Between 100 and 130 kg

We Choose a Baseline Weight of 115 kg

26

How We Estimated the Maximum Range of the Improvised Chemical Munition Used in the August 21, 2013 Nerve Agent Attack on East Ghouta

27

Important Basic Result – The Rocket Behaves Like a Balloon
That Is, Its Range Is Dominated By the High Aerodynamic Drag from Its Body-Shape

- The Range Does Not Change Drastically with Significant Changes in the Body Weight or Due to Uncertainties in the Aerodynamic Drag Coefficient.
- Due to Volume and Fuel Density Constraints, Our Assumption of Rocket Propellant Carried by the Munition is at the Top End of What is Possible.

This Means that Our Estimated Maximum Range of 2 km for the Improvised Munition Is Close to its Upper Possible Range!

In Turn, It Means That the US Government's *Interpretation of the Technical Intelligence* It Gathered Prior to and After the August 21 Attack ***CANNOT POSSIBLY BE CORRECT***

28

Differences in the Flight Trajectory of Baseline Chemical Munitions Due to Uncertainties in Weight, Propellant Loading, and Aerodynamic Drag

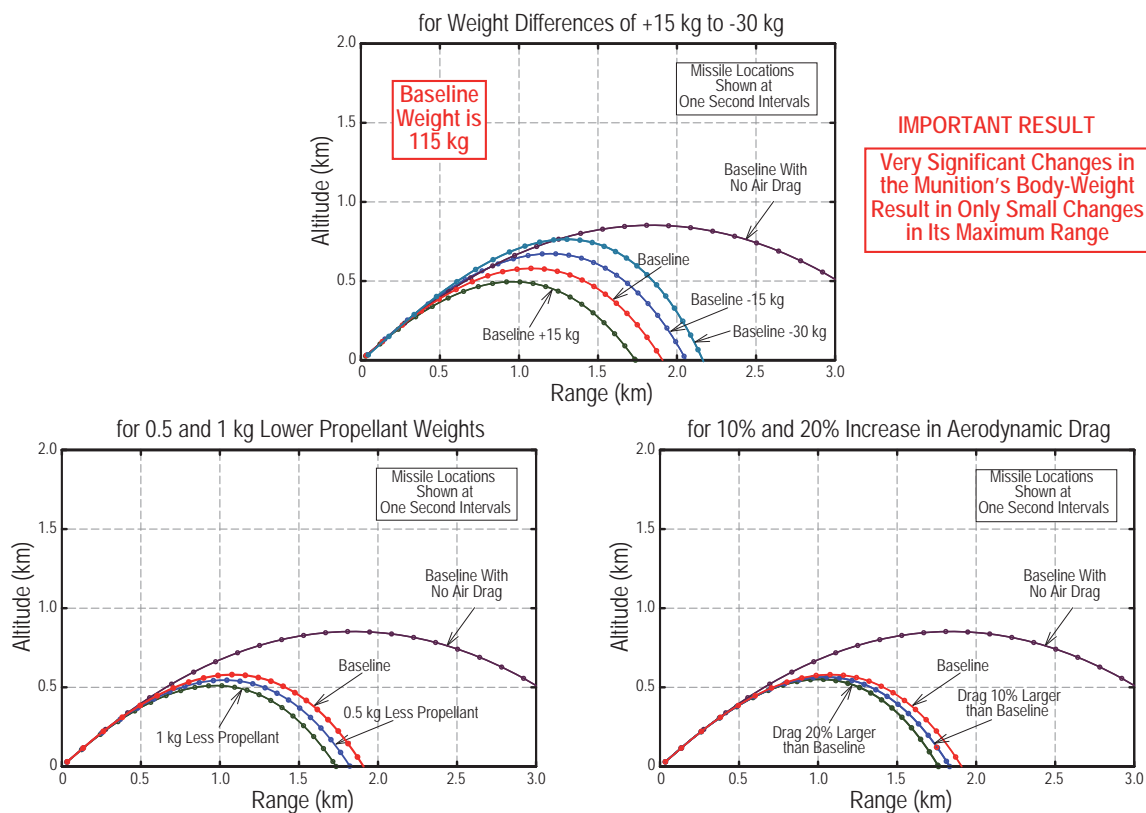

29

Forces Acting on GRAD Artillery Rocket During Powered and Free Flight

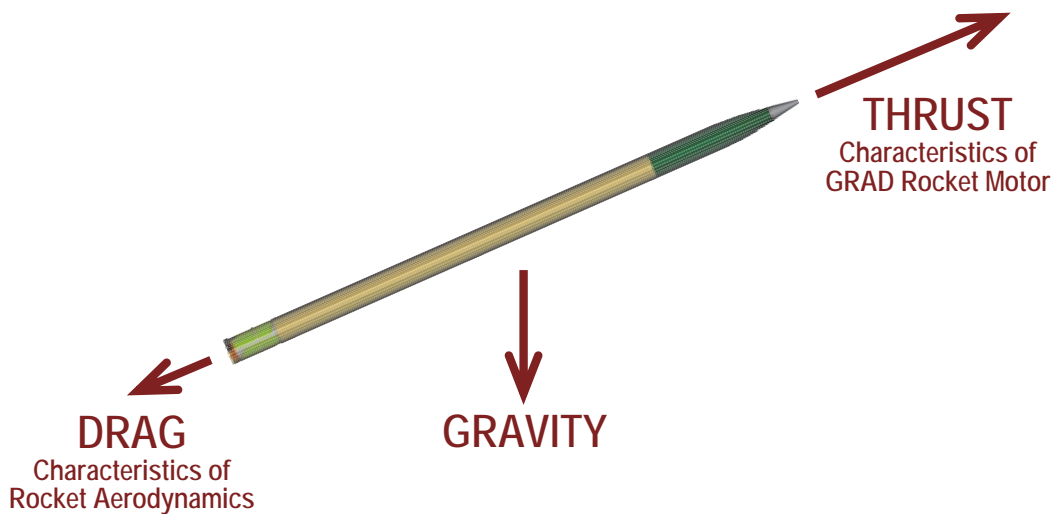

GRAD
 Speed Immediately After Burnout - 690 m/s (Mach2.1)
 Drag Forces Immediately After Burnout -280 lbs
 Motor Generates About 9000 lbs of Thrust for About Two Seconds

Improvised Chemical Munition
 Speed Immediately After Burnout -220 m/s (Mach0.66)
 Drag Forces Immediately After Burnout -600 lbs
 Motor Generates About 5000 lbs of Thrust for About Two Seconds

30

TACTICAL AND TECHNICAL CHARACTERISTICS OF THE 122mm ROCKETS "GRAD" AND THEIR MODIFICATIONS

Basic characteristics of the existing "GRAD", "G-M" and "G-2000" at nominal

	GRAD	G-M	G-2000	Units
Caliber	122	122	122	mm
Length	2875	2875	2875	mm
Temperature range	-30 ± 50	-30 ± 50	-30 ± 50	°C
Total mass	66	68.7	69.0	kg
Warhead mass with fuse	19.1	19.1	19.1	kg
Propellant mass	20.45	25.8	27.3	kg
Burning time	2.0	2.5	2.7	s
Total motor impulse	39700	52700	62800	Ns
Specific motor impulse	1941	2042	2300	Ns/kg
Max. velocity at X _e .	690.6	915	1100	m/s
Top of the trajectory at X _e .	7100	11100	17800	m
Time of flight at X _e .	76	96	126	s
Elevation	50.0	50.0	56.9	°
Range (X _e)	20.3	27.5	40.2	km
Caliber	122	122	122	mm

Characteristics of GRAD Rocket Motor Needed to Determine Missile Trajectory

Trajectory Characteristics that Result from GRAD Rocket Motor Properties

The Drag Coefficient of the Syrian Chemical Rocket and the GRAD Artillery Rocket

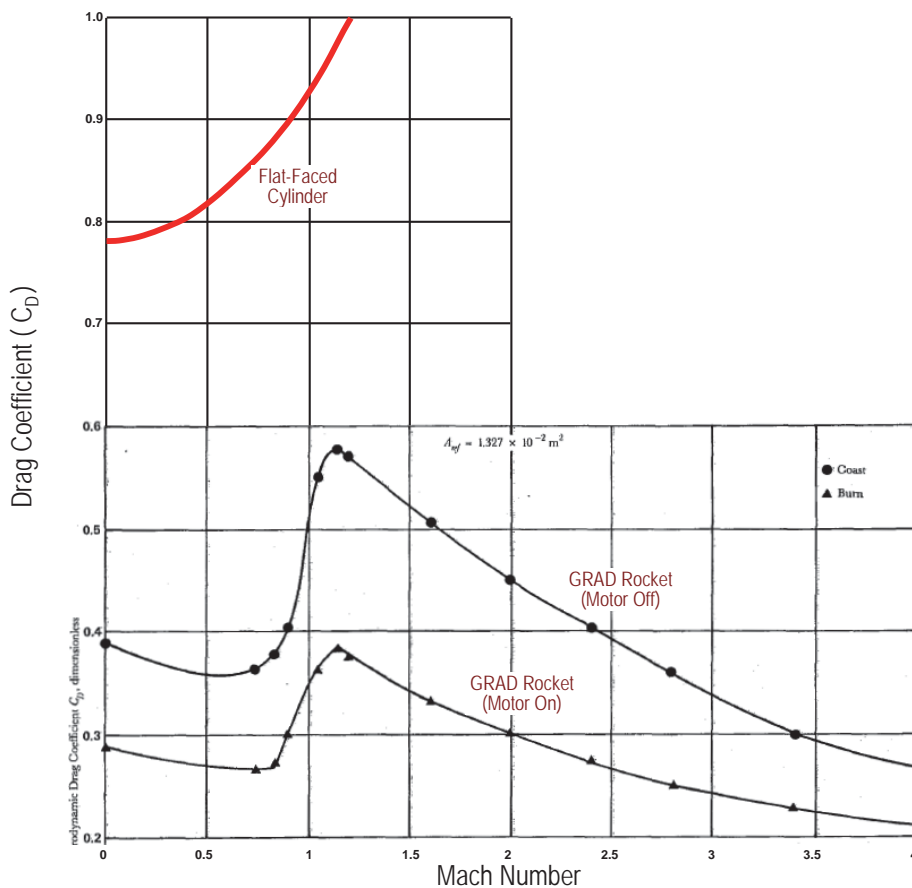

Comparison of the Trajectories of the GRAD Artillery Rocket with the Trajectory of the Syrian Improvised Chemical Rocket When Both Rockets Use Motors with the Same Propellant and Specific Impulse

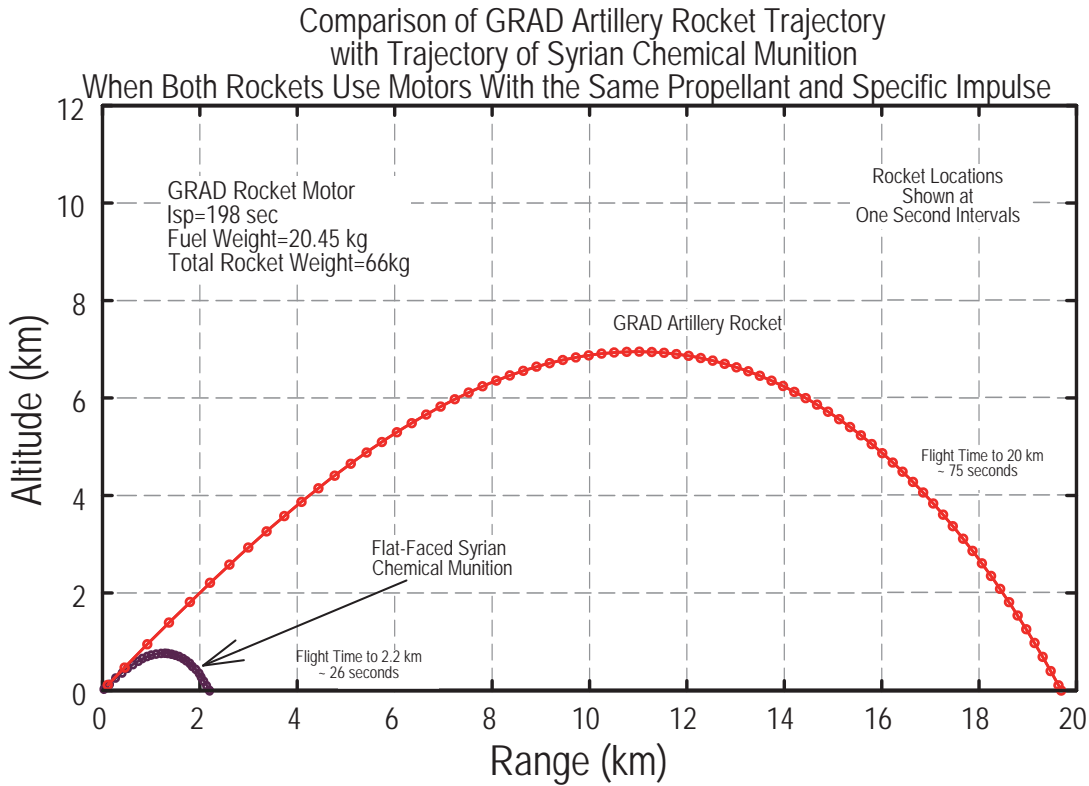

33

Our Trajectory Calculations Compared to Published Trajectory Data on GRAD Artillery Rocket

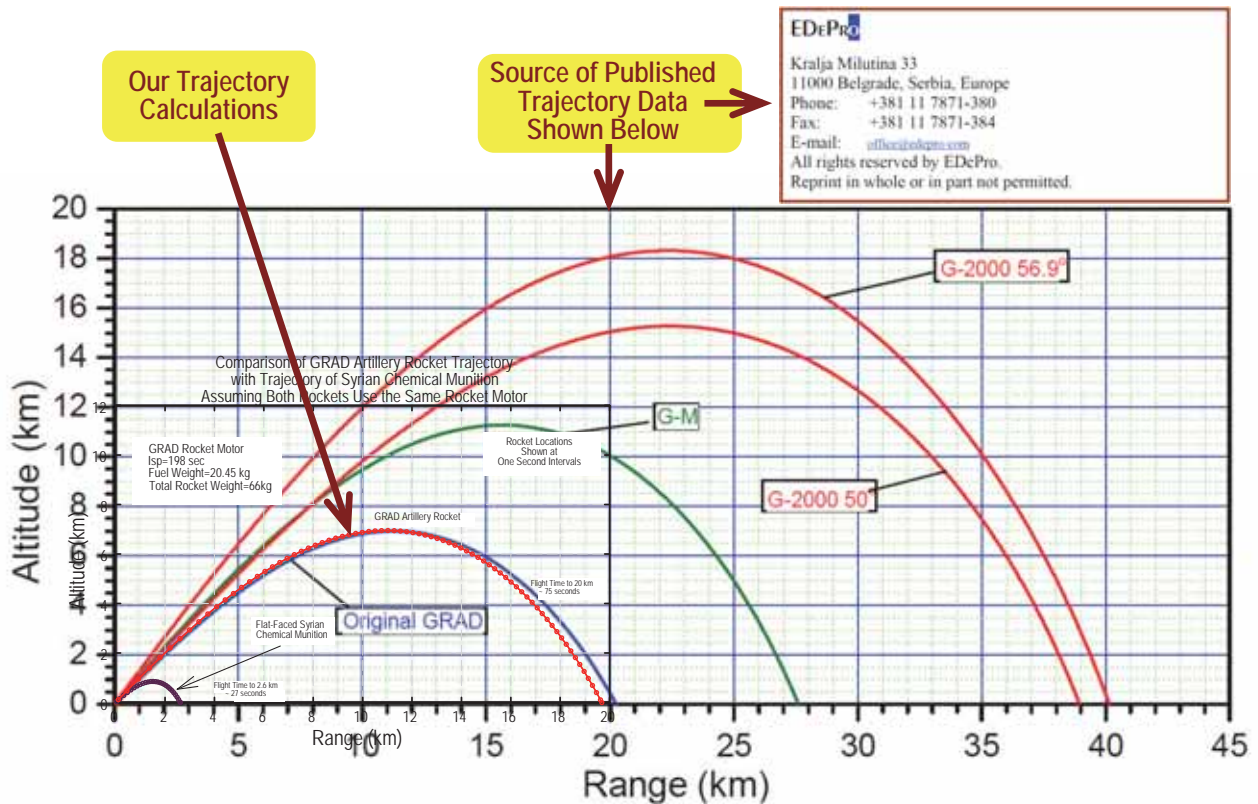

GRAD-Rocket Drag Coefficient (C_D) Near Mach 1 May be too High by About 7-8%

34

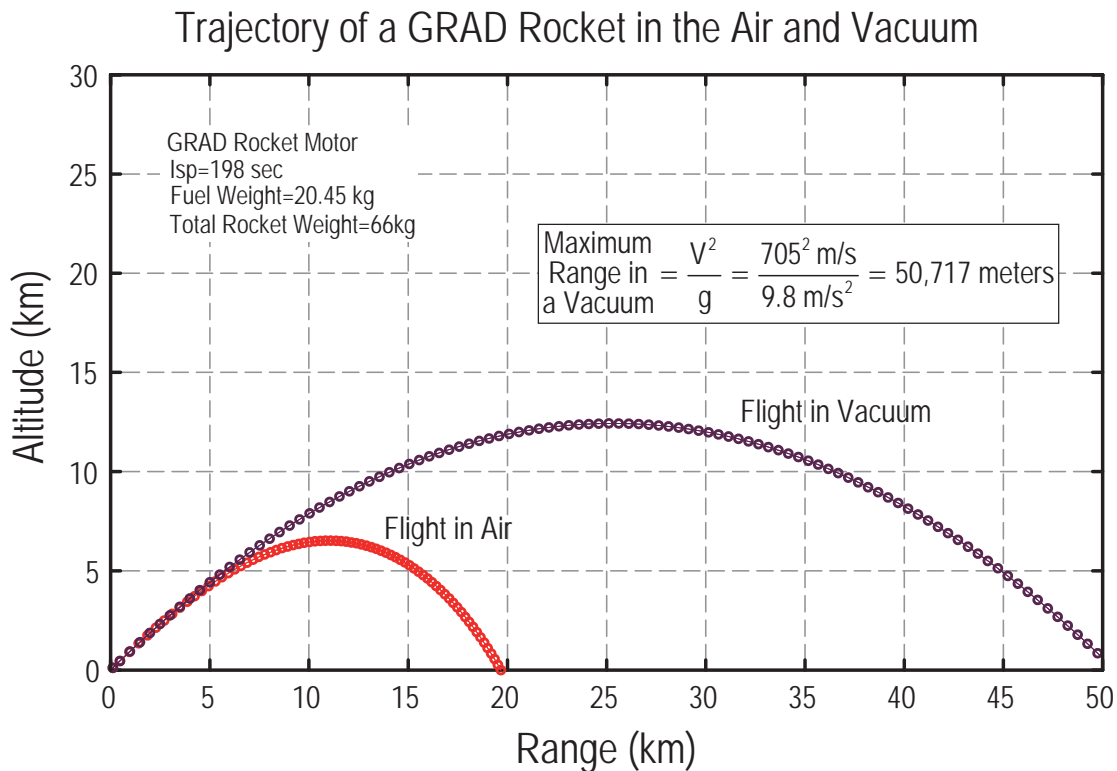

35

THE BOTTOM LINE

- The Syrian Improvised Chemical Munitions that Were Used in the August 21, Nerve Agent Attack in Damascus Have a Range of About 2 Kilometers
- This Indicates That These Munitions Could Not Possibly Have Been Fired at East Ghouta from the “Heart” or the Eastern Edge of the Syrian Government Controlled Area Depicted in the Intelligence Map Published by the White House on August 30, 2013.
- This faulty Intelligence Could Have Led to an Unjustified US Military Action Based on False Intelligence.
- A Proper Vetting of the Fact That the Munition Was of Such Short Range Would Have Led to a Completely Different Assessment of the Situation from the Gathered Data
- Whatever the Reasons for the Egregious Errors in the Intelligence, the Source of These Errors Needs to Be Explained.
- If the Source of These Errors Is Not Identified, the Problems That Led to this Intelligence Failure Will Go Uncorrected, and the Chances of a Future Policy Disaster Will Grow With Certainty.

36

APPENDIX

Appendix: How Aerodynamic Drag Occurs

37

How Aerodynamic Drag Occurs

$$\text{Drag Force From Air Movement} = \frac{1}{2} \rho V^2 C_D A$$

$$\delta V_{\text{Air}} = C_D V_x$$

$$M_{\text{Air}} = \rho \delta X \delta Y \delta Z = \rho \delta Y \delta Z (V_x \delta t)$$

$$\text{Drag Force Due to Air Movement} = M_{\text{Air}} A_{\text{Air}} = M \left(\frac{\delta V_{\text{Air}}}{\delta t} \right) = (\rho \delta Y \delta Z V_x) (C_D V_x)$$

$$\text{Drag Force Due to Air Movement} = (\rho \delta Y \delta Z V_x) (C_D V_x) = C_D \rho V_x^2 A$$

Where A is the projected area of the object in the flow field
 ρ is the density of the air
 V_x is the velocity of the object relative to the air

By Convention, C_D is defined so that the equation for drag can be written as,

$$\text{Drag Force From Air Movement} = \frac{1}{2} \rho V^2 C_D A$$

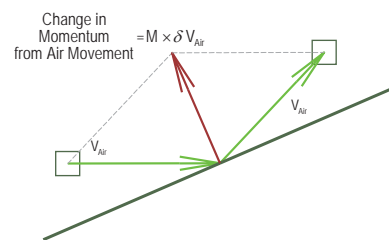

38

Difference in Drag Forces Due to the Different Geometries of the Air Flow

$$\text{Drag Force From Air Movement} = \frac{1}{2} \rho V^2 C_D A$$

Explanation of How Aerodynamic Drag Forces Are Generated

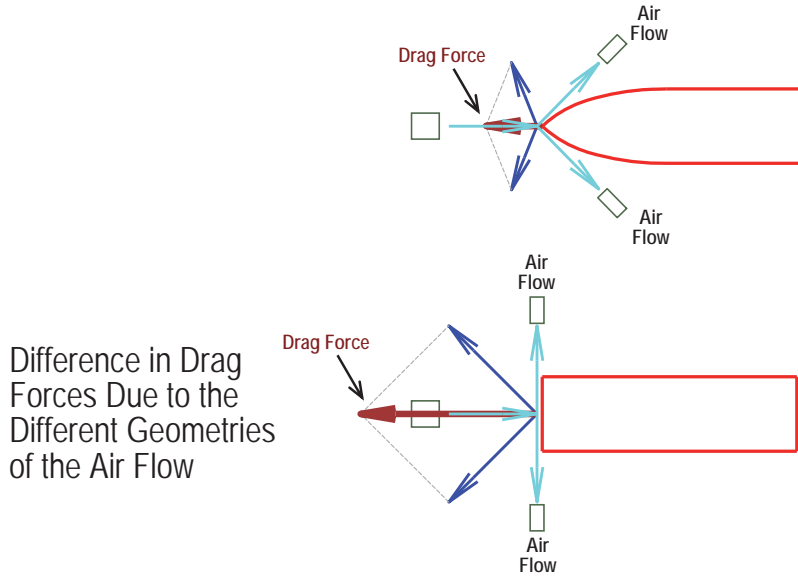

Drag Coefficient Used in Our GRAD Artillery Rocket Trajectory Calculations

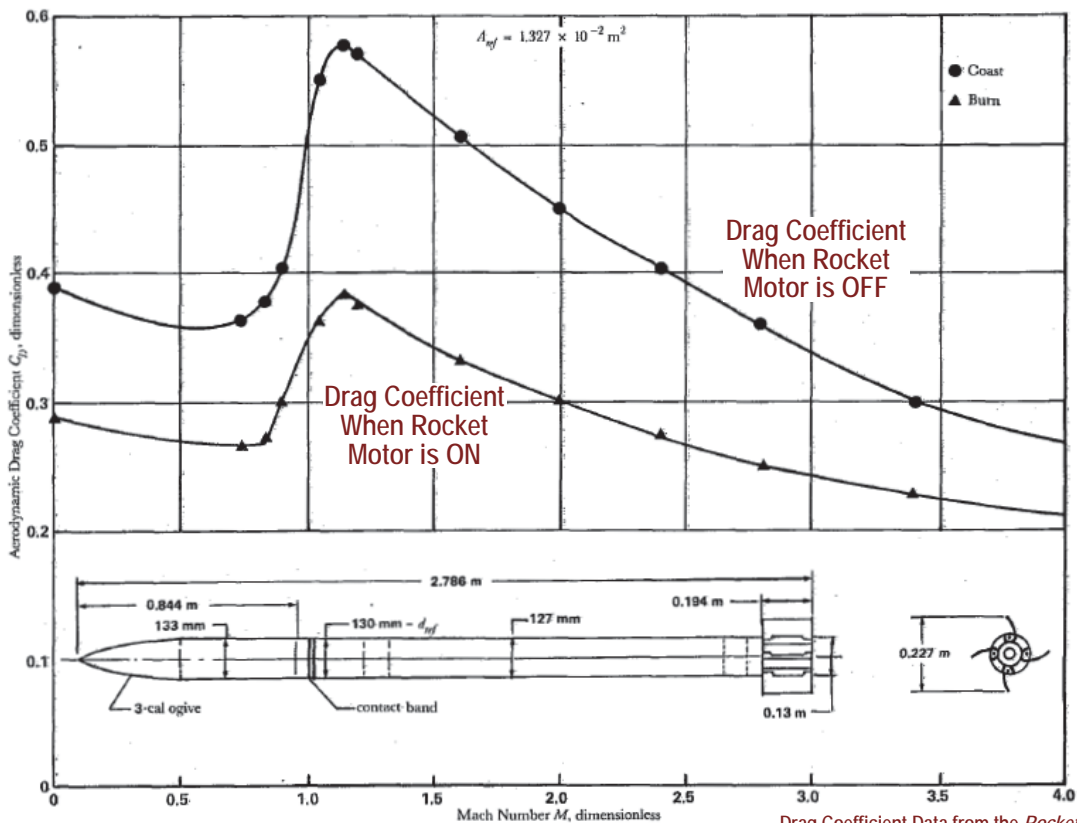

Drag Coefficient Data from the *Rocket Artillery Reference Book*. Available at:
<http://rapporter.ffi.no/rapporter/2009/00179.pdf>

APPENDIX

Appendix: Data Source on Rocket Motor Parameters of the GRAD Rocket

41

Data Source on Rocket Motor Parameters of the GRAD Rocket (Pages 1 and 2 of 8 Pages)

http://www.edepro.com/wp-content/uploads/2013/03/R122_G2000_Cargo.pdf

MLRS "GRAD" AND ITS MODIFICATIONS



MLRS "GRAD" Cargo

"G-M" ROCKET

"G-M" rocket is basically a refurbished original rocket GRAD. The overhaul objectives were just a few changes resulting in the best possible performance.

WHY THE OVERHAUL?

- ◆ The lifetime of the existing rocket has been extended for another 10 years
- ◆ Considerable range increment (see Diagram D-1)
- ◆ Saving of financial funds
- ◆ Packing of the rocket, launcher and logistics remain the same
- ◆ No additional training of personnel for its application is required
- ◆ The overhaul is easy, quick and carried out with the Customer

The modification is primarily made in the propellant grain (which has the shortest life). The new propellant grain is in one piece, it is shaped and inhibited along the outer surface at one end. The rocket propellant used in its production is the modern thermoplastic composite propellant made according to the original technology. The propellant has a similar burning temperature as the original one, but has a higher specific impulse, which enables the use of the original nozzle assembly. The propellant grain is not bonded to the new motor combustion chamber, which enables the overhaul of the rocket to be performed at the premises of the End User.

The overhaul of the rocket is quick and easy without requiring any special technology or machinery. By using a large number of components from the existing rockets with expired propellant grain life, the overhaul saves a lot of money if compared to supply of new rockets.

The outer appearance of the new rocket remains the same as the original one. The conditions of storage, transportation and handling remain also the same.

Main new rocket parts:

- Propellant grain
- Combustion chamber
- Motor igniter assembly
- Motor closure
- Parts for thermal isolation

Main existing rocket parts:

- Warhead with fins
- Nozzle assembly with fins
- Rocket guide
- Contact cover
- Packing of the rocket

Schematic review of the overhaul is given in Figure 1.

42

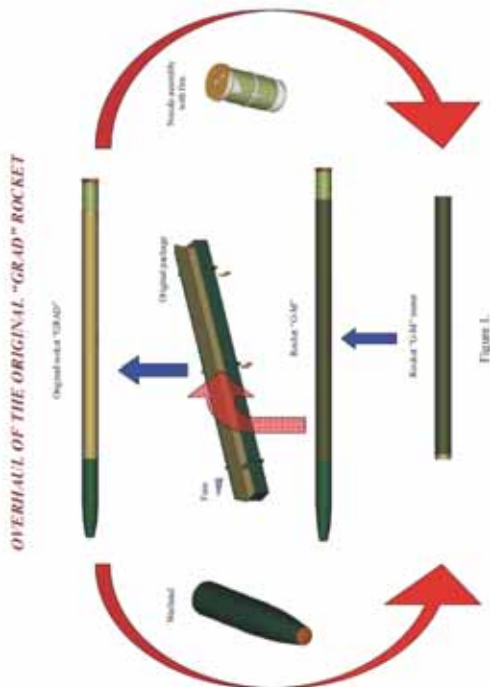

Figure 1.

Rocket "G-M" is fully compatible to the mobile multi tube rocket launchers such as BM-21 and RM-70, or similar existing launchers. Underlining that this modified (overhauled) rockets also may use the original rings for stage reduction.

The End Customer will receive a full set of all new components required for overhaul as well as the instruction manual for overhaul, quality control and acceptance of the rockets.

If the Customer is interested it is possible to supply all tools and accessories required for the overhaul as well as to train the Customer's personnel.

The modified rocket "G-M" may be delivered as a completely new rocket, without using any components from the old rockets.

In that case this rocket will be delivered in its original package with required documentation for application.

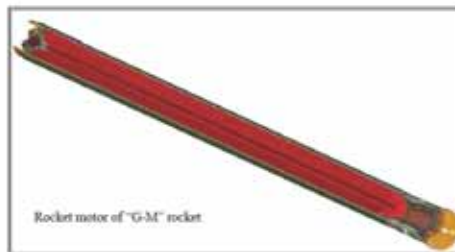

Comparative technical characteristics of the rocket are given in Table T-1, and on Diagram D-1.

"G-2000" ROCKET

Rocket "G-2000" within its caliber is currently the longest-range rocket. Its rocket motor has a completely new and the latest state-of-art design, which is also very simple. Warhead with fuse, rocket guide and contact cover are identical with the original rocket "GRAD".

Rocket "G-2000" is fully compatible to the mobile multi tube rocket launchers such as BM-21 and RM-70, or similar existing launchers.

Underlining that this rockets also may use the original rings for stage reduction.

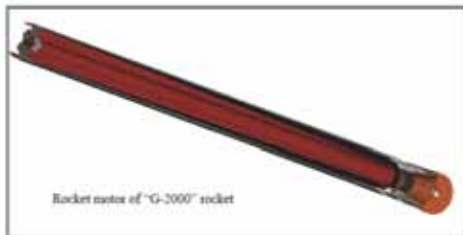

Rocket motor of "G-2000" rocket

Propellant grain is a single piece of cylinder shape, which is inhibited along the outer surface and front end. It contains two types of propellant, which differs in the burning rate. This has resulted in a high level loading factor, almost neutral burning and the sliver has been minimized.

Rocket propellant, which is used for grain production, is a modern thermoplastic composite propellant with a high percentage of aluminum, burning temperature exceeding 3000K and high value of specific impulse.

The steel nozzle with abraded ablative material has one graphite throat.

Comparative technical characteristics of the rocket are given in Table T-1, and on Diagram D-1.

TACTICAL AND TECHNICAL CHARACTERISTIC OF THE 122mm ROCKETS "GRAD" AND THEIR MODIFICATIONS

Basic characteristics of the existing "GRAD", "G-M" and "G-2000" at nominal (firing-table) conditions are given in following table.

Table T-1.

TECHNICAL CHARACTERISTICS	"GRAD" ORIGINAL	"G-M"	"G-2000"	Units
Caliber	122	122	122	mm
Length	2873	2873	2873	mm
Temperature range	-30 + +30	-30 + +30	-30 + +30	°C
Dimensions	66	66.7	69.0	kg
Weight (empty with fuse)	19.1	19.1	19.1	kg
Propellant mass	20.43	23.8	23.3	kg
Burn time	2.0	2.5	2.7	s
Total impulse	19700	22700	42800	Ns
Specific impulse	1941	2042	2390	Ns/kg
Max velocity %	890.8	933	1100	m/s
Top of trajectory %	73.00	110.00	170.00	m
Time of flight %	78	96	126	s
Elevation	30.0	30.0	36.9	°
Range (Ce)	20.3	27.3	40.2	km
CEP (max range)	1.27	0.96	0.66	m

CEP values of "G-M" and "G-2000" rockets are obtained in way that the tolerances of total mass of the rockets are kept below 0.1 kg and tolerances of the Total Impulse of Solid Rocket Motors are 0.1%.

In order to prove the quality of our rockets and accentuation of their advantages we are ready to perform flight tests on your or our flight-test facilities for both rockets "G-M" and "G-2000".

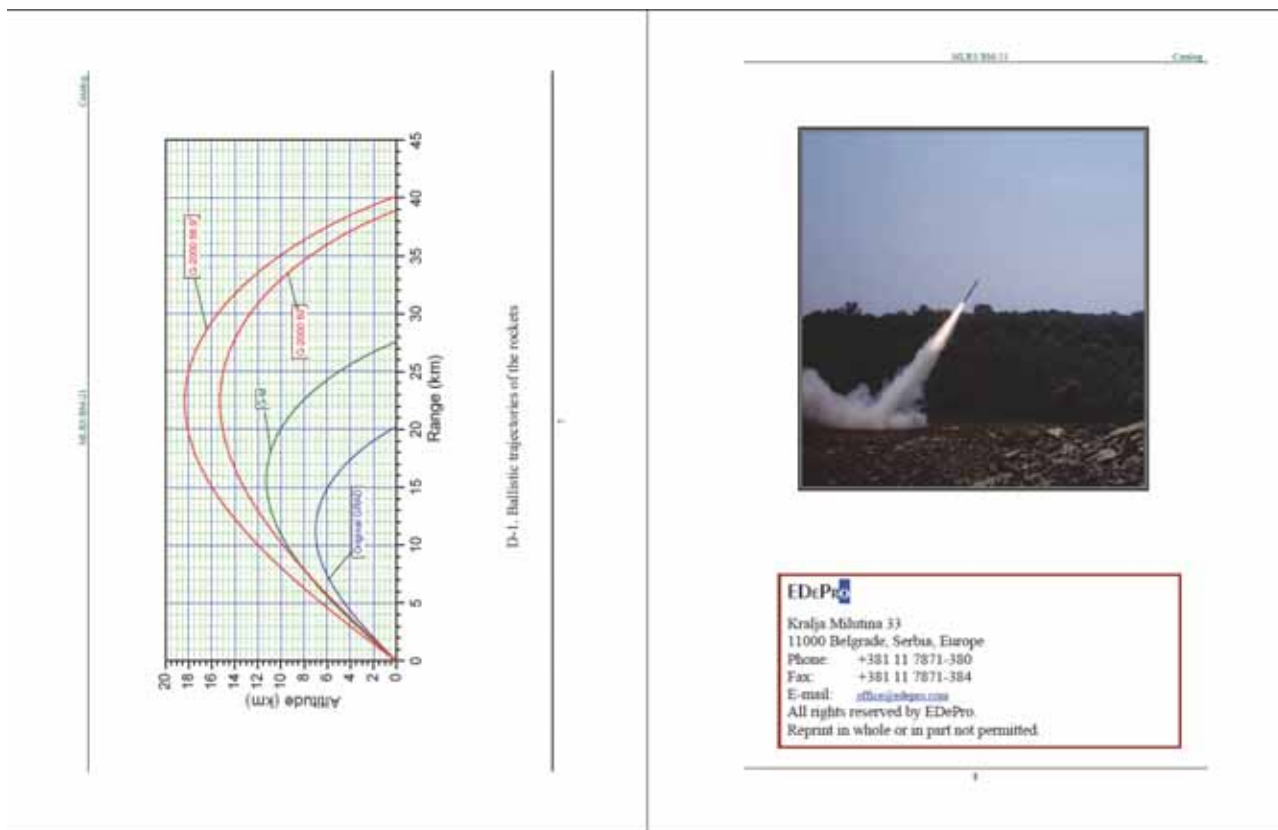

Answer to Question from the Press About the UN's Assessment of the Range of the Chemical Munition Used in the Nerve Agent Attack of August 21, 2013 in Damascus:
Åke Sellström, Head of Mission, of the *United Nations Mission to Investigate Allegations of the Use of Chemical Weapons in the Syrian Arab Republic*

Åke Sellström Statement

We have seen problems – like you have seen others performing whatever studies on these rockets and we have consulted with experts, and if you simulate the flight path it seemed not to meet – may be indicated from the report – you may draw a conclusion from the report two kilometers could be a fair guess. I would assume, but it all depends, you have to sort of set some parameters which we do not know to what extent they were filled or with what they were filled with. We don't know their weight or whatever, but two kilometers could be a fair guess.

Between 15:55 to 16:47 on the YouTube Video at: <http://www.youtube.com/watch?v=5CFn9pWNKcI>

NOTE: Our calculations show that the exact weight of the munition is not an important determinant of its range.

Rough Sequence of Events with Regard to Public Awareness of This Issue

Tesla/MIT Draft Materials on Rocket's Range Limitations Begin to Circulate on Blogs in Early December (12/4 or so)

UN Discusses Its Own Assessment in Response to Press Question on December 13, 2013

New York Times Publishes Article About Developing Tesla/MIT Analysis on December 28, 2013